



DJ1191-Ex
DJ1192-Ex
AJUT24-Ex

Cerberus®

Response indicators

for explosion-hazard areas in zones 1 and 2

-
- **DJ1191-Ex, DJ1192-Ex:**
 - Modern flat design
 - Non-screw terminals
 - **AJUT24-Ex:**
 - Simple plug-in, expanding-spring socket
-

Response indicators are connected to automatic fire detectors in order to indicate quickly the source of an alarm signal from detectors which are not easily accessible or visible.

The response indicators contain an indicator lamp unit with one resp. two LEDs. They light up as soon as the connected fire detector gives an alarm.

Only *one* external response indicator may be connected to each detector.

Response indicators DJ1191-Ex, DJ1192-Ex

Response indicators are mounted with two screws either directly to a door frame (DJ1191-Ex), or on a wall (DJ1192-Ex).

For the following applications the DJ1192-Ex can be completed with AI330 adapter frame:

- for surface laid conduit or ducts
- to increase the loop space
- as an adapter for different makes of box

Dimensions

DJ1191-Ex

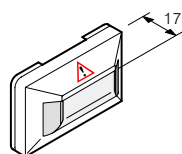
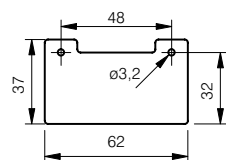

DJ1192-Ex

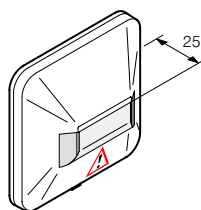
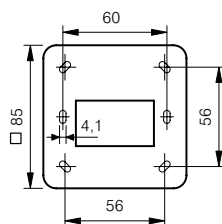

AI330

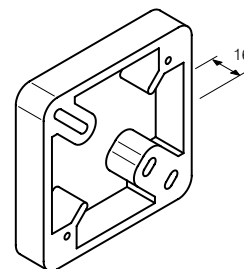
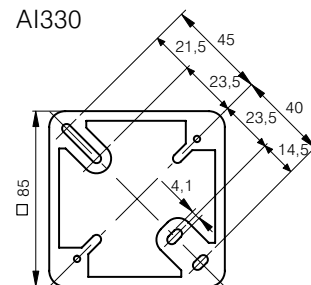

Connection

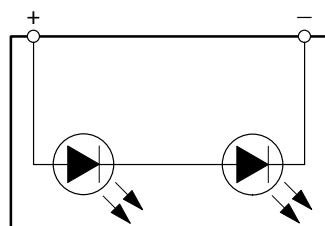

Response indicator AJUT24-Ex

Made of transparent plastic, the AJUT24-Ex response indicator is suitable for installation in door frames, switching panels, ceiling voids or special housings. The 23mmØ mounting hole is drilled by the system owner.

The holder is fitted with an insulating cap for safety.

For installation in humid rooms the DJZ1193 and DCA1191 housings as well as a washer are available.

The housing DJZ1193 has a hole for the mounting of one response indicator.

Up to 4 response indicators can be built into the housing DCA1191. The 23mmØ mounting holes are drilled by the system owner.

Dimensions

AJUT24-Ex

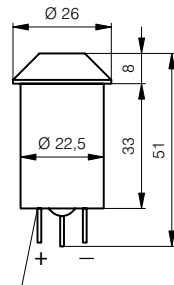

Red spot

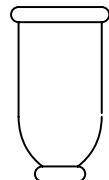

Insulating cap

DJZ1193

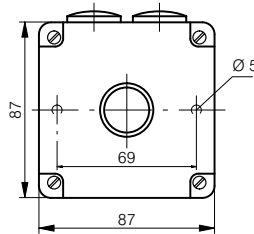
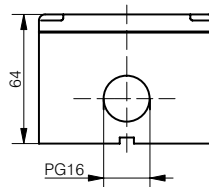

DCA1191

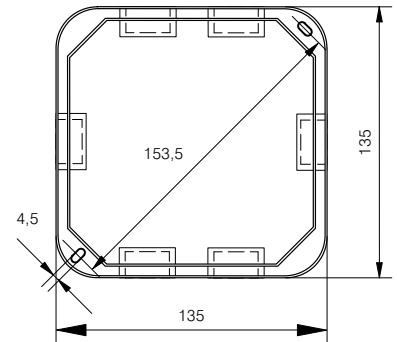
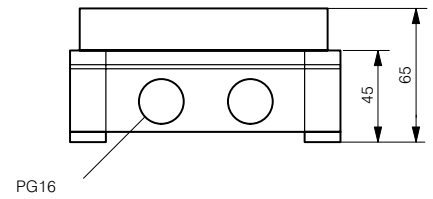

Connection

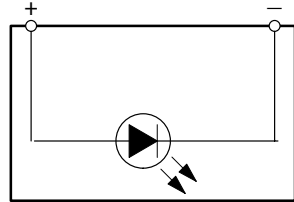

Technical data

	DJ1191-Ex, DJ1192-Ex	AJUT24-Ex
Operating voltage	4...5VDC	1.5VDC
Operating current, continuous	max. 35mA	max. 20...30mA
Terminals	max. 1.5mm ²	max. 1.5mm ²
Ambient temperature	-25...+80 °C	-25...+80 °C
Humidity	<95% r.h.	<95% r.h.
Protection category EN60529 / IEC529	IP40	-
- with DJZ1193	-	IP65
- with DCA1191	-	IP56
Colour	white, ≈RAL9010	white, ≈RAL9010 (housings DJZ1193, DCA1191)
Ex classification	EEx ib IIC T* * T6 (T _a ≤55°C) T5 (T _a ≤70°C)	EEx ib IIC T* * T6 (T _a ≤55°C) T5 (T _a ≤70°C)
Approvals	EECS, ESTI	EECS, PTB, ESTI

Details for ordering

	Type	Part no	Designation	Weight
DJ1191-Ex, DJ1192-Ex	DJ1191-Ex	478344	Response indicator	0,020kg
	DJ1192-Ex	478357	Response indicator	0,050kg
	AI330	316943	Adapter frame for DJ1192-Ex	0,020kg
AJUT24-Ex	AJUT24-Ex	278544	Response indicator	0,010kg
	-	304816	Insulating cap	0,005kg
	DJZ1193	530295	Indicator housing, incl. washer	0,115kg
	DCA1191	458856	Housing with cover	0,265kg
	-	247313	Washer	-

